

Datablad

FLEX/FLEX E for metal/plast



Vare:
Beskrivelse:

025738400030
Norma Connect Kobling
FLEX W2 Ø=30,0 NBR, 16
bar

Mål

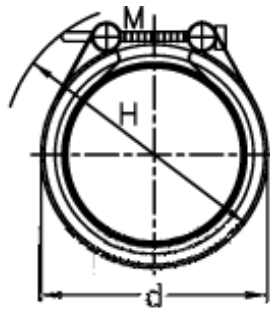
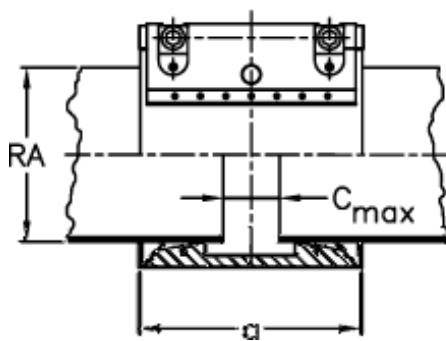

a	=	67.0
d	=	50
H	=	70
RA	=	30.0

C max med båndindlæg: 3
M (Skrue): M8
Nominelt tryk (bar): 16.0
RA min-RA max: 28,6-30,5
Vægt pr stk.: 0.4

Dokumenter, målskitser og brochurer af enhver slags kan indeholde fejl for hvilke Brd. ikke hæfter.