

WOLTMANN WATER METER PN16 MID R100



Size : DN 50 to 200
Connection End : Flanged R.F. PN10/16
Min Temperature : 0°C (for cold water type)
Max Temperature : + 90°C (for hot water type)
Max Pressure : 16 Bars
Specifications : Horizontal Woltmann
Dry dial
Magnetic transmission

Materials : Cast iron body

WOLTMANN WATER METER PN16 MID R100
SPECIFICATIONS :

- Horizontal Woltmann with interchangeable insert
- **MID R100 range** in horizontal or vertical position(respect the flow direction indicated by the arrow)
- Dry dial
- Magnetic transmission
- Direct reading on numerical rolls
- With lid
- Cast iron body

USE :

- Water distribution
- Min and max temperature Ts : 0°C to 30°C for cold water type **Ref.1738 and 1758**
- Min and max temperature Ts : 30°C to 90°C for hot water type **Ref.1739 and 1748**
- Max Pressure Ps : 16 bars

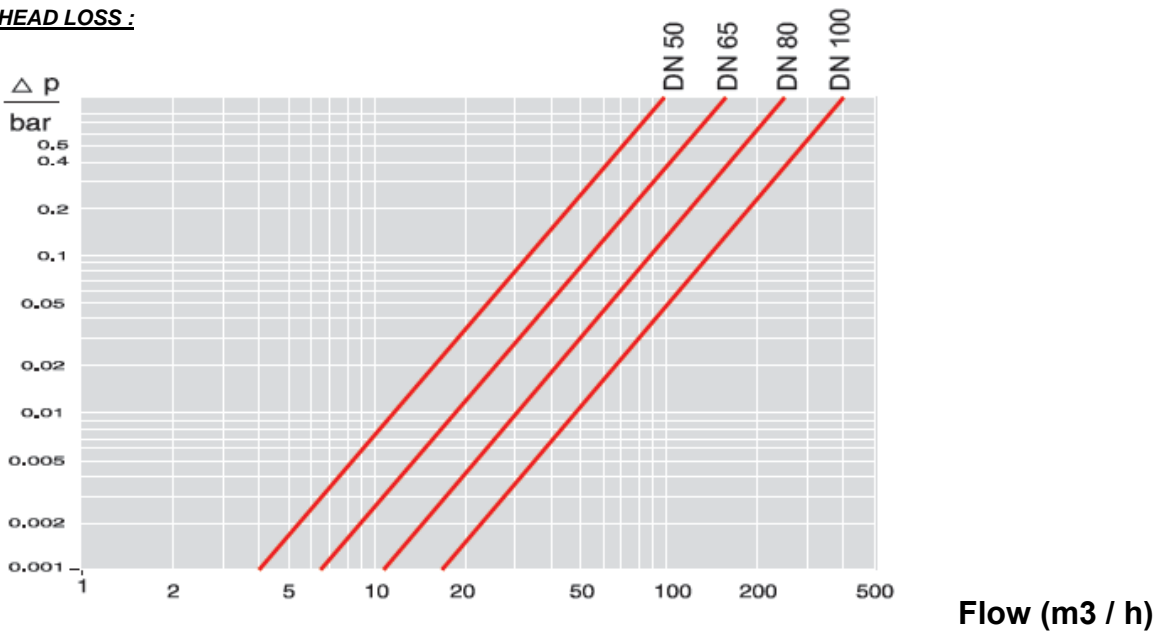
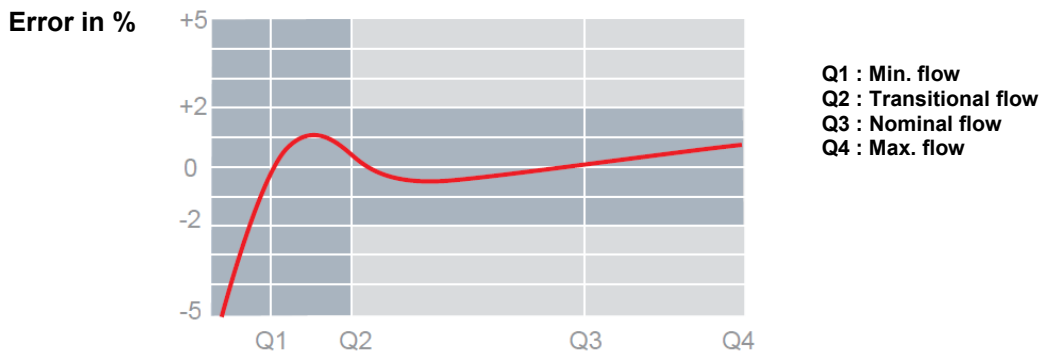
HEAD LOSS :

TYPICAL ERROR CURVE :

Q1 : Min. flow
 Q2 : Transitional flow
 Q3 : Nominal flow
 Q4 : Max. flow

WOLTMANN WATER METER PN16 MID R100
RANGE :

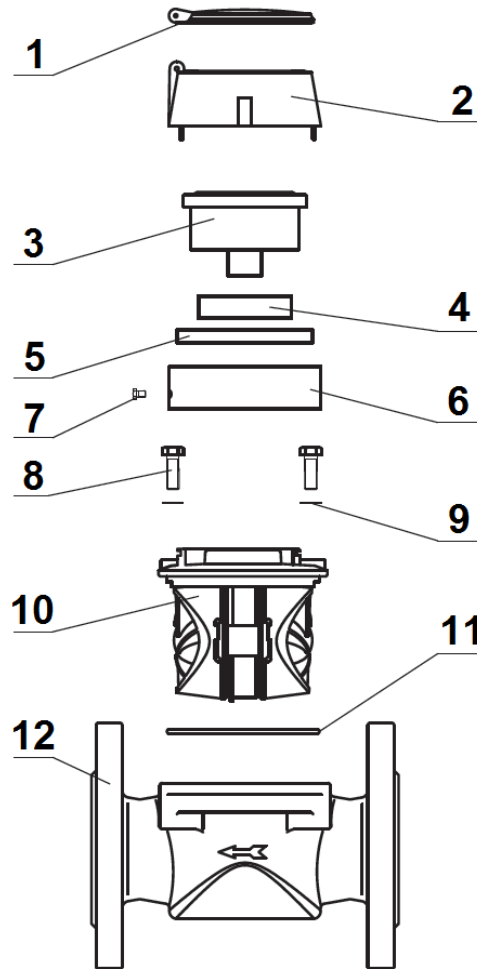
- Cold water meter flanged PN10/16 **Ref.1738 DN 50 to 200**
- Hot water meter flanged PN10/16 **Ref.1739 DN 50 to 200**
- Cold water meter flanged PN10/16 with impulse emitter (1x100L) **Ref.1758 DN 50 to 200**
- Hot water meter flanged PN10/16 with impulse emitter (1x100L) **Ref.1748 DN 50 to 200**

MATERIALS :

Item	Designation
1	Lid
2	Cup
3	Counter with glass 6 mm thickness
4	Antimagnetic ring
5	Plate
6	Ring cup
7	Sealing screw
8	Screw
9	Washer
10	Mechanism
11	O ring
12	Cast iron body

WOLTMANN WATER METER PN16 MID R100**ACCESSORIES :**

- LCD counter **Ref. 1749021**



- LCD counter with reset **Ref. 1749023**



- Double LCD counter with reset **Ref. 1749022**



- Wireless radio MBUS converter **Ref. 1749006**



- MBUS converter PAD PULSE **Ref. 1749015**

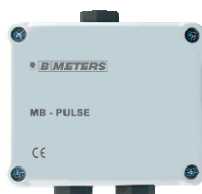

- MBUS converter PAD PULSE up to 4 meters **Ref. 1749017**

WOLTMANN WATER METER PN16 MID R100

SIZE (in mm) :

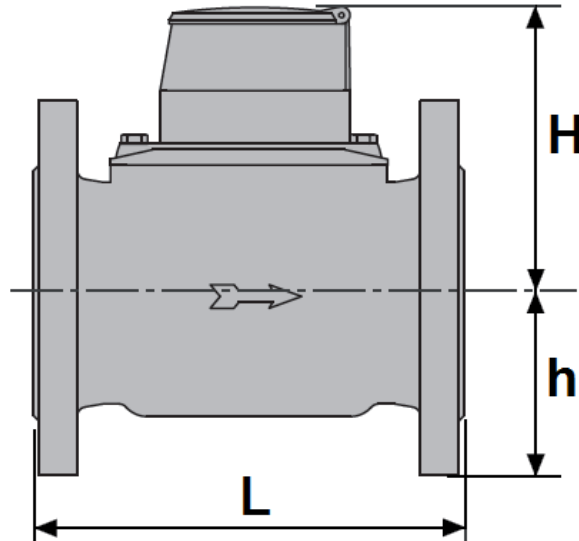

Ref	Calibre	50	65	80	100	125	150	200
1738 1739 1748 1758	L	200	200	225	250	250	300	350
	h	78	87	95	106	117	134	165
	H	123	123	149	147	274	311	365
	Weight (Kg)	8.1	9.3	14.5	16.6	20.5	33.6	43.6

FLANGES SIZE (in mm) :

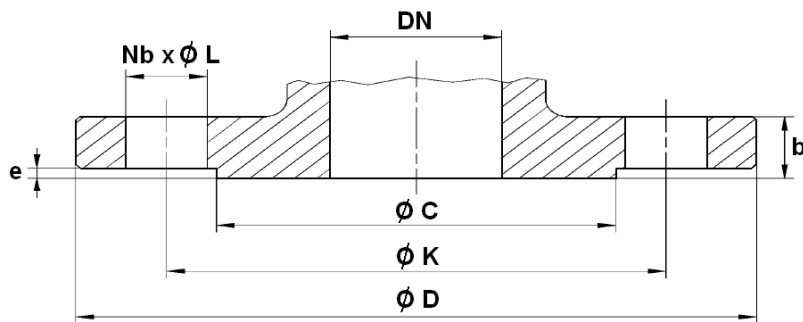

Ref.	DN	50	65	80	100	125	150	200
1738	Ø C	102	122	138	158	188	212	268
	Ø D	165	185	200	220	250	285	340
1739	Ø K	125	145	160	180	210	240	295
1748	Nb x Ø L	4 x 18	4 x 18	8 x 18	8 x 18	8 x 18	8 x 22	12 x 22
1758	b	20	18	20	20	22	22	24
	e	2	2	2	2	2	2	2

WOLTMANN WATER METER PN16 MID R100
TECHNICAL FEATURES :

DN	50	65	80	100	125	150	200
Max flow Q4 max (m3/h)	50	78.7	125	200	200	312.5	500
Nominal flow rate Q3 (m3/h)	40	63	100	160	160	250	400
Min flow Q1 ± with 5% error (m3/h)	0.40	0.63	1.00	1.60	1.60	2.5	4
Transitional flow rate Q2 with ± 2% error (L/h)	0.64	1.008	1.6	2.56	2.56	4	6.4
Min reading (l)	0.5	0.5	0.5	0.5	0.5	5	5
Max reading (m3)	999999	999999	999999	999999	999999	9999999	9999999
Max head loss ΔP at nominal flow rate Q3 (bar)	0.16	0.25	0.16	0.25	0.16	0.16	0.1617

IMPULSE EMITTER SPECIFICATIONS :

REED contact

- Max voltage : 24 V
- Min voltage : 0.02 V
- Max bearable Current : 1.2 A
- 2 wires cable 3 meters lenght
- Normally opened contact
- Contact in Rhodium
- Contact rating 10W
- Switching current 0.5A
- Max resistance contact 0.1 Ohm
- Min breakdown voltage 150V
- Min insulation resistance 10⁹ Ohm
- Max operate time 0.5 ms
- Max release time 0.3 ms
- Max capacitance 0.5 pF
- Min resonant frequency 5000 Hz
- Max operation frequency 400 Hz
- Max switching voltage : 24 V
- Min voltage : 0.02 V
- Max current : 1.2 A
- Cable 2 wires 3 meters long

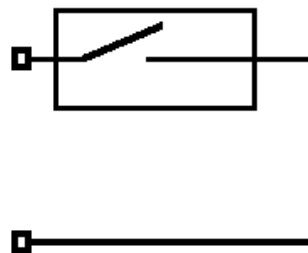
PULSE POSSIBILITIES :

Pulse Number	By multiple of
1	100 liter for bore 50 to 150
	1000 liter for bore 200

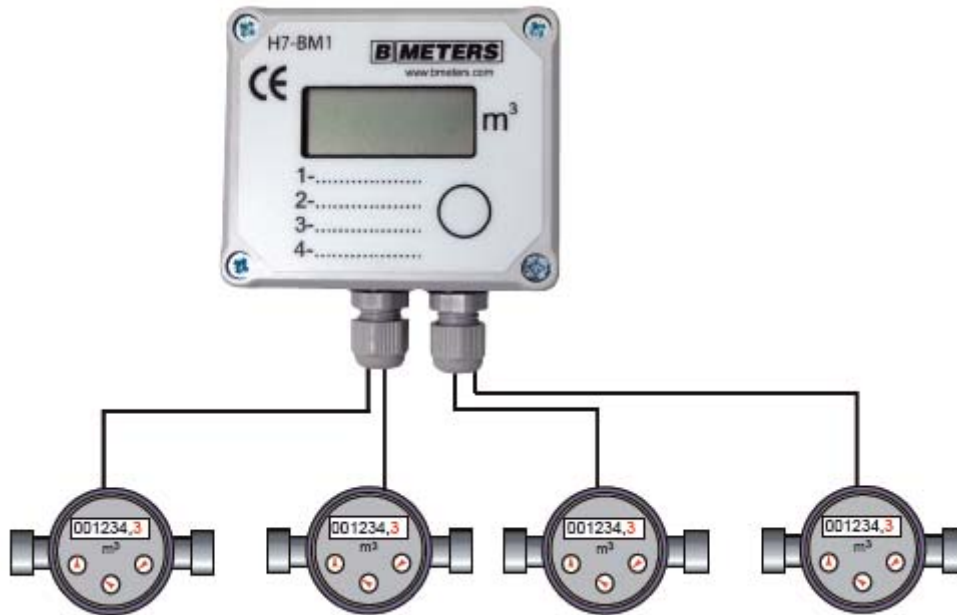
WOLTMANN WATER METER PN16 MID R100**LCD COUNTER (OPTION) :**

Use of this device allows grouping and reading of the impulse signals generated by up to 4 water meters. It is possible to set the pulse value for each input signal independently.

- Up to 4 entries
- Max reading : 1999.999 m³
- Settable impulse values : 1, 2.5, 10, 25, 100 or 1000 L/impulse
- Wall mounting with 2 screws Ø6 mm
- Power supply by lithium battery (8 years lifetime)
- External dimensions : 89 x 73 x 42 mm
- IP protection : IP54

WOLTMANN WATER METER PN16 MID R100
LCD COUNTER SETTING :

H7-BM1 is equipped with 3 buttons and LCD display.
 K1 button is located externally near LCD display.
 K2 and K3 buttons are located internally as showed in the following picture.

K1 button is used in normal operating mode, for switching the display view to another channel.

Setting the pulse value

- Press button K1 for choosing the correct channel.
- Wait until the reading value appears.
- Press the button K2, the display shows the current pulse value.
- It is possible to change the pulse value by pressing button K3.
- For setting the value you can press button K2 or wait a few seconds.

Set the starting reading value

- Press button K1 for choosing the correct channel
- While the display show the channel number, press button K2. In this way the figure starts flashing indicating the quantity of liters.
- Press button K3 for setting the desired starting reading value. You can press button K2 for moving to the second position.
- Repeat the previous operation for all the positions showed on the display. After pressing button K2 on the last position, the reading value is stored.

Attention

It is possible to set the starting reading value after having initially set the pulse rate.

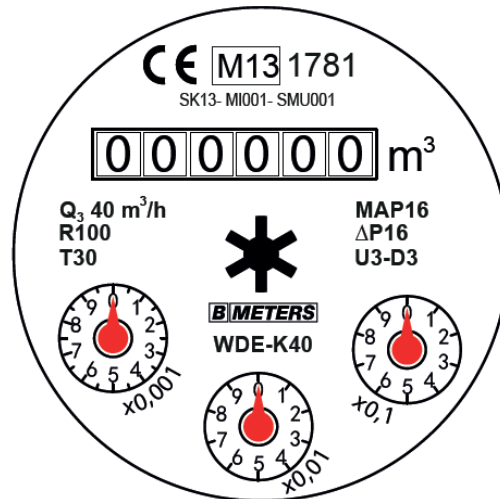
WOLTMANN WATER METER PN16 MID R100**DIAL :****STANDARDS :**

- Fabrication according to ISO 9001 : 2008 ICIM and IQNET
- Flanged according to EN 1092-2 PN16
- DIRECTIVE 97/23/CE : Products excluded from directive (article 1, § 3.2)
- Water meter according to **2004/22/CE MID annex B**

ADVICE : Our opinion and our advice are not guaranteed and Lauridsen Industri shall not be liable for the consequences of damages. The customer must check the right choice of the products with the real service conditions.

WOLTMANN WATER METER PN16 MID R100
INSTALLATION INSTRUCTIONS OF WATER METER
BEFORE INSTALLATION :

Pipe-line must be cleaned and free from residual of weldings, rubbish, shaving and every kind of extraneous materials.
 Pipe-line must be perfectly aligned and their support properly dimensioned so that there's no external constraint.
 Tighten the bolts in cross
 Use the right bolt tightening so that the ends won't be damaged.

It's recommended to install a strainer before the water meter if there are some solid particles in the water.
 Installation of the meters in the vicinity of pumps must be avoided. It is advisable to install the meter as far as possible from them.

Make sure all the water supply outlets, served by the meter, sit higher than the meter itself otherwise its metering precision could be altered. The highest position of the count itself as the recording of the counter may not be reliable. To address these possibilities, simply place the meter after a 'large upward curve that ensures always a pipe completely filled with water (Fig 1). This will prevent air bubbles that could affect the accuracy of measurement

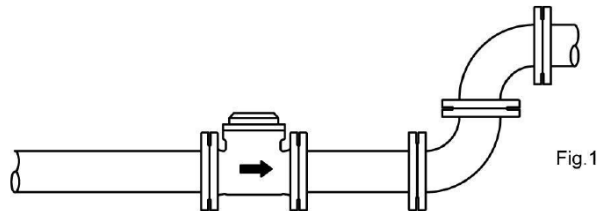

Respect the flow direction indicated by the arrow.

We recommend installing a valve downstream and one upstream of the meter in order to facilitate a possible maintenance of the meter itself, without having to drain the complete pipeline.

During the water meter commissioning it is advisable to open first the valve placed downstream of the meter (so to flood the mechanical part of the instrument) and then slowly open the valve located upstream of the meter. This will prevent possible water hammers or acceleration of the flow that could damage the moving parts of the instrument.

In the event of devices installed upstream of the water meter (gate valves, curves, elbows, tees, reducers, ...) it is recommended to follow the following points. These devices can generate flow turbulence that in the long run may damage the moving parts of the measuring instrument. The L1 and L2 lengths above are considered the minimum necessary. When possible, you should increase them.

Valves placed upstream and downstream

$$L1 \geq 15xDN$$

$$L2 \geq 2xDN$$

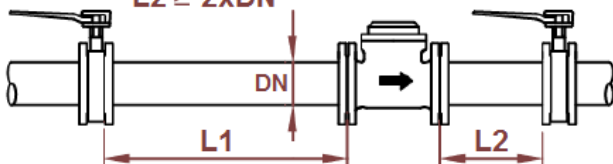
Upstream bottleneck

$$DN1=1.5xDN \quad L1 \geq 20xDN$$

$$DN1=1.15xDN \quad L1 \geq 10xDN$$

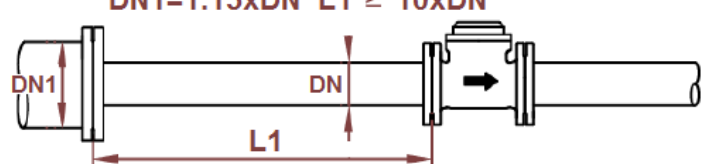
Curve or T fitting

$$L1 \geq 15xDN$$

$$L2 \geq 2xDN$$

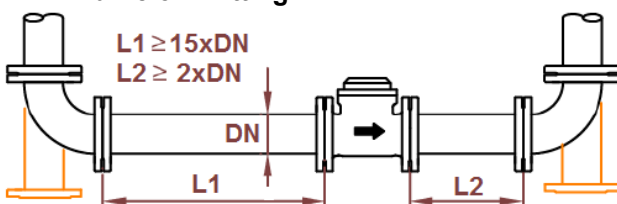
Upstream bottleneck with conical fitting

$$DN1=1.5xDN \quad L1 \geq 10xDN$$

$$DN1=1.15xDN \quad L1 \geq 5xDN$$

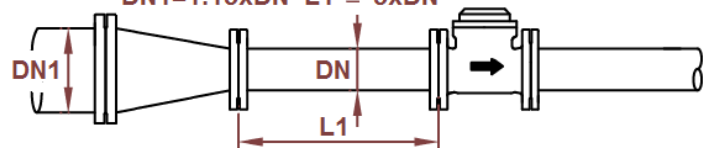

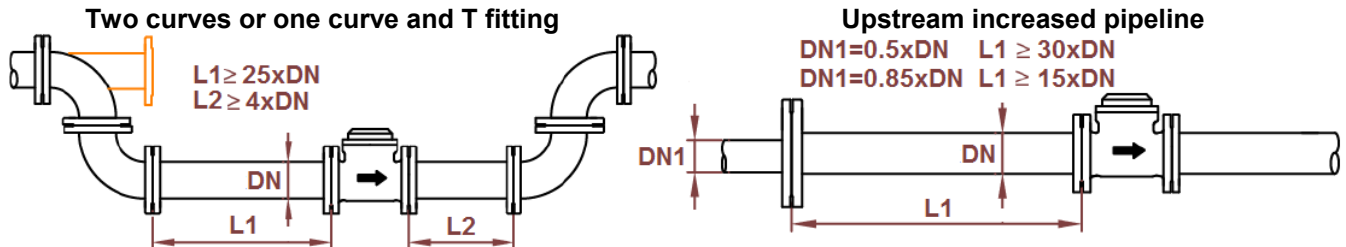
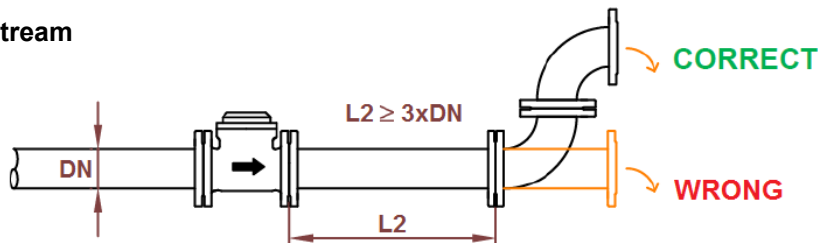
WOLTMANN WATER METER PN16 MID R100
INSTALLATION POSITIONS (SUITE) :

Free discharge downstream

TESTS :

During the tests under pressure, water meter must be removed to avoid overpressure risks.

INSTALLATION

Please make the water flow slowly to avoid water hammer.
 The meter pit shall be protected from flooding, rainwater and frost.

INSTALLATION POSITIONS :

The counter should be normally placed in an horizontal position
 The counter can be installed vertically with ascending flow or tilted without suffering any damage.
 If necessary, the counter can be installed vertically with descending flow but the pipe should always be full of water in this case.

NOTE: Never install the water meter in horizontal position with totalizer in upside down orientation.

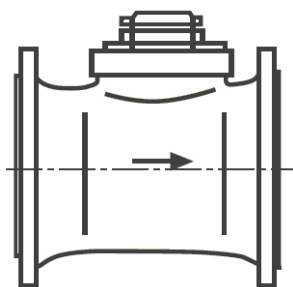
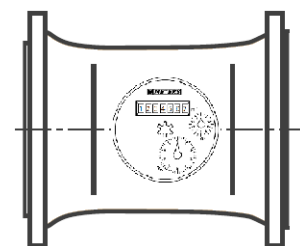
HORIZONTAL :

MID R100

MID R100

(Vertical dial assimilated to vertical position)

WOLTMANN WATER METER PN16 MID R100

INSTALLATION POSITIONS :

VERTICAL* :

* : In vertical position,
the pipe should always be full of water.

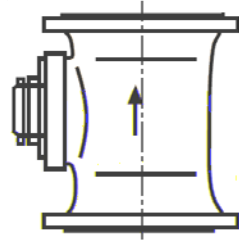
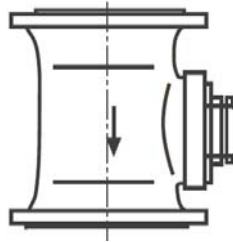

MID R100